

InfraTec Premium

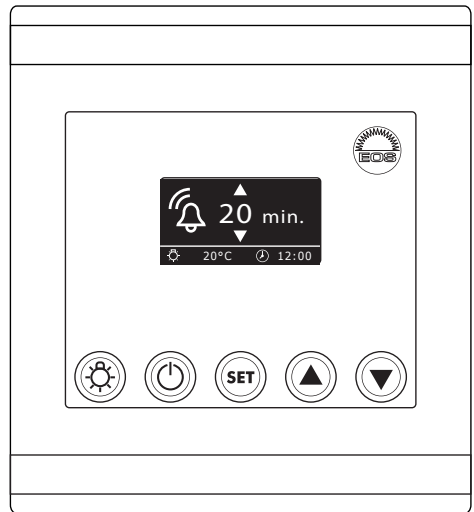

(GB) Assembly and operating instruction

Made in Germany



Table of Contents

Technical data	4
Scope of delivery	4
General information	5
General safety precautions	5
Assembly	6
Power element	6
Terminal	7
Wall mount fixture	7
Laying the line	7
Electrical Connection	8
Adapting the control to the installed components	8
Installation diagram	9
Terminal arrangement on the circuit board	9
Connection diagram for IR radiant heaters	10
Connection diagram for IR heating foils	11
Connection diagram for IR radiant heaters and IR heating foils	12
Connecting the sensor cables	13
Installation of the room sensor	13
Installation of the optional heating foil sensor	14
Operation	15
General	15
The user interface	15
Operating buttons	15
Default display Stand-by	16
Default display in operation	16
Energy-saving display	16
Initial commissioning	17
Change language	18
Change time	18
Foil temperature	19
Switching on the IR system	20
Switching off the IR system	20

Individual settings.....	21
Room temperature.....	21
Room temperature for heating foil operation	22
Radiant heater for legs.....	23
Radiant heater for back.....	24
Front radiant heater	25
Heating time.....	26
Error messages.....	27
Service Address:.....	28
Guarantee	28
Handling procedures for return shipments (RMA) - Details for all returns !	29

Technical data

Mains voltage:	230 V N AC 50 Hz
Fuse:	1 x 16 A
Output :	max. 3500 W
Control range:	30 - 70° C
Control characteristics:	Digital output control
Sensor system:	KTY sensor
Heating time limitation:	1 - 99 minutes / 0 -12 hours
Ambient temperature:	-10 to 40° C
Installation dimensions HxWxD:	139 x 194 x 49 mm

Scope of delivery

(subject to changes)

Included in control unit scope of delivery:

- Control power unit
- Plastic bag containing four mounting screws 4 x 20 mm
- Control operating console
- Circuit board for room sensor with over-temperature protection, KTY sensor and sensor housing, two mounting screws 3 x 25 mm and sensor cable ca. 3.0 m long, red.

Dear customer,

with the purchase of this IR control unit, you have opted for a superior quality, high-tech electronic device which has been developed and manufactured according to the highest standards and guidelines.

Please read the guidelines in these instructions carefully so that you can familiarise yourself quickly and easily with the unit.

General information

The IR control unit products in the standard series are intended to run on voltages of 230 V 50 Hz and are to be provided with a separate 16 A fuse.

The installation and connection of the sauna facilities and other electrical operating equipment may only be carried out by a specialist from an authorised specialist electrical company; here VDE 0100 Part 703/2006-2 must be observed.

Please read the following installation and operating instructions through carefully so that your IR system can be operated without malfunctions.

- Please also follow the information and instructions provided by the cabin manufacturer.

General safety precautions

- The unit may only be used for its intended purpose as a control for IR radiant heaters or IR heating foils up to max. 3.5 kW.
- The electrical installation may only be performed by an authorized electrician.
- You must comply with the regulations of your utility company as well as the standard VDE-guidelines (DIN VDE 0100).

- **CAUTION! Danger of death:** Never carry out repairs and installations yourself. Only a qualified technician may remove the housing cover.
- Caution: The control power element may not be installed in enclosed switching cabinets or be enclosed in wooden panelling!
- The unit may only be used for its intended purpose as a control for IR radiant heaters.
- The system must be disconnected at all poles from the mains during all installation and repair work, meaning that you must switch off all fuses or the main switch.
- Follow the safety and installation information provided by the manufacturer.
- This unit is not intended for use by persons (including children) with restricted physical, sensory or mental capacity or by persons without the necessary experience and/or knowledge unless they are supervised by someone responsible for their safety or receive instructions from them on how to use the unit.
- Children are to be supervised in order to ensure that they do not play with this device.
-  Only IR radiant heaters acc. DIN 60335 or IR heating foils with integrated overheating protection (140°C) may be connected.
- Follow the safety and installation information provided by the IR radiant heater manufacturer.

Assembly

Power element

The power switchgear may only be installed outside the cabin. It is advisable to select the outside wall of the cabin or the cabin ceiling for the installation. If ductwork is provided for the electrical installations then the position of the power switchgear is predetermined by that. Please follow the instructions for installation:

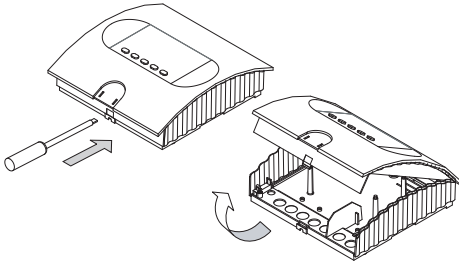

Fig. 1

1. Remove the cover of the power element. To do this, push the retaining tang to the inside with a flat screwdriver and pivot the housing top upwards (Fig. 1).

The 5 mm diameter boreholes for the supplied wood screws 4 x 20 mm are drilled according to the dimensions shown in Fig. 2.

2. Insert one of the wood screws into the top center hole. The power element is hooked onto this screw. Therefore, leave the screw out by ca. 3 mm (Fig. 3).
3. Hook the power element to the 3 mm protruding screw in the upper mounting hole.

Insert the supplied rubber grommet into the openings at the rear wall of the housing and insert the connecting cable through these openings.

Fasten the bottom section of the housing firmly to the cabin wall or cabin ceiling by

inserting the screws into the two lower boreholes (Fig. 4).

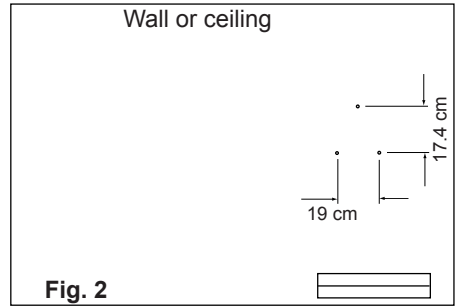

Fig. 2

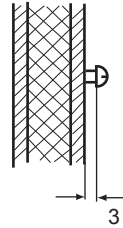
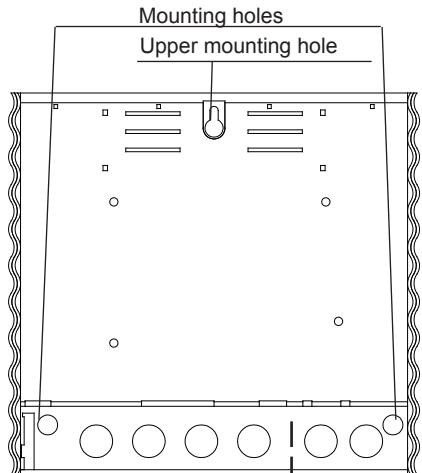

Fig. 3



Feed-throughs for:
Mains supply line
IR radiant heater /
IR heating foils
Lamp

Feed-through
for sensor
lines

Fig. 4

Terminal

Wall mount fixture

The control unit may only be mounted outside the cabin. It is advisable to select the outside wall of the cabin. If ductwork is already provided for electrical installations then the position of the control unit is pre-determined by that. The installation may be mounted flush with the cabin wall or embedded into the cabin wall. Please follow the instructions for installation:

First define the place of assembly.

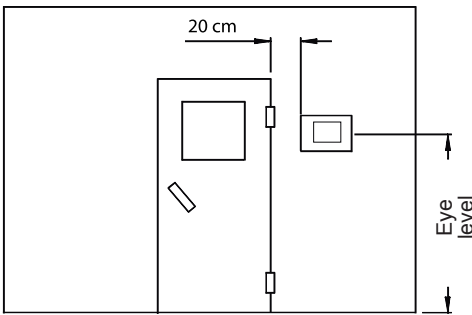

Fig. 5

Make a wall opening to a size of 105 mm (width) X 90 mm (height) X 25 mm (min. depth).

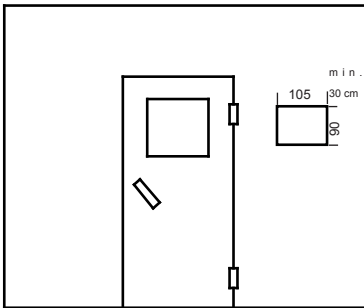

Fig. 6

Laying the line

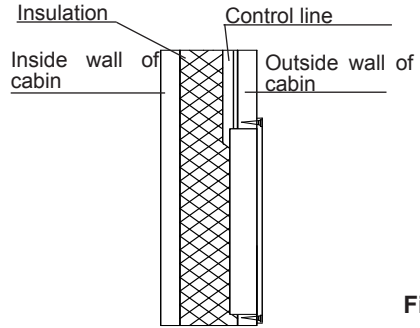

Fig. 7

Lay the control line from the terminal to the control power unit.

The control line may only be laid between the insulation and the outside wall of the cabin (Fig. 7).

(The insulation must be designed for max. outside temperature of 75 °C.)

Mount the terminal in the wall opening and fix it with the 4 screws enclosed.

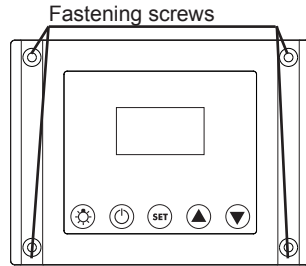

Fig. 8

Then adhere the self-adhesive decorative strips into the longitudinal grooves of the terminal.

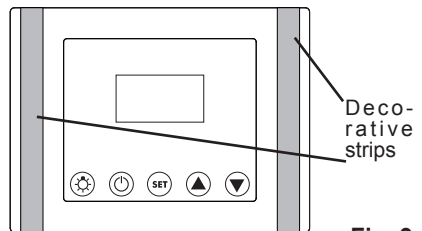

Fig. 9

Electrical Connection

The electrical connection may only be done by a certified electrician in compliance with the guidelines of the local utility company and the VDE.

Connection is carried out using a Schuko plug, to be mounted by the customer, to a separate Schuko socket with a 16A fuse.

All electrical installations and all connection lines that are installed inside the cabin must be suitable for an ambient temperature of at least 170 °C.

Lay the lines from the individual components to the control power unit and connect according to the connection diagram.

If more than one radiant heater is to be connected per heating circuit, the respective lines must be connected in junction boxes provided by the customer outside the power unit. The terminals on the circuit board may only be allocated one line.

Lay the control line(s) from the control element to the power switchgear and produce the plug connections according to the connection diagram.

Adapting the control to the installed components.

On the circuit board of the IR control power unit you will find a pin block for three jumpers

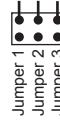

The type of emitters used is set using the jumpers 1 + 2.

IR radiant heater

If exclusively IR radiant heaters are installed, both jumpers remain open

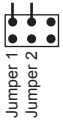

IR heating foil

If IR heating foils are installed, Jumper 1 is connected and Jumper 2 remains open.

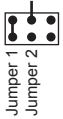

A radiant heater for the legs can also be installed

IR radiant heater & IR heating foil

If both IR radiant heaters - except for the radiant heater for legs - and IR heating foils are installed, Jumper 2 is connected and Jumper 1 remains open.

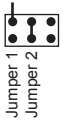

You can set the maximum heating time with Jumper 3

Maximum heating time 99 minutes
Jumper 3 open

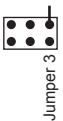

Maximum heating time 12 hours
Jumper 3 closed

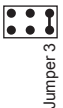

Installation diagram

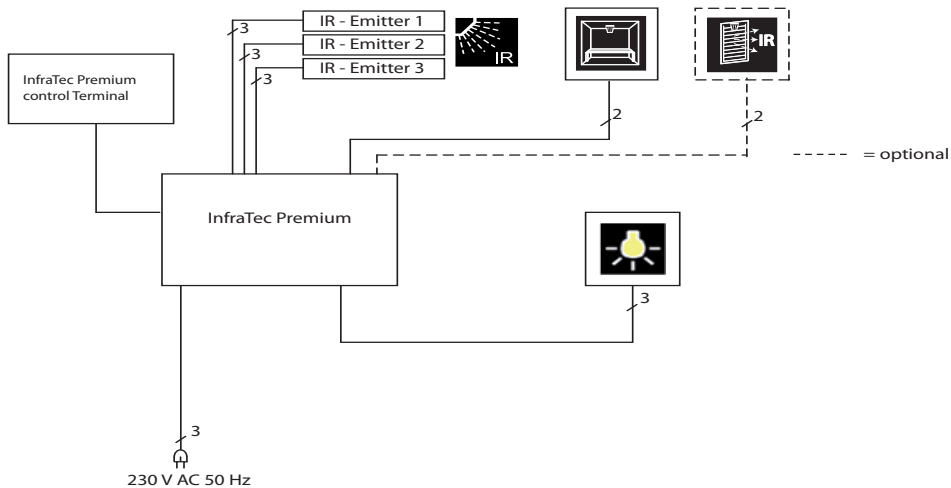

Terminal arrangement on the circuit board.

(Power unit)

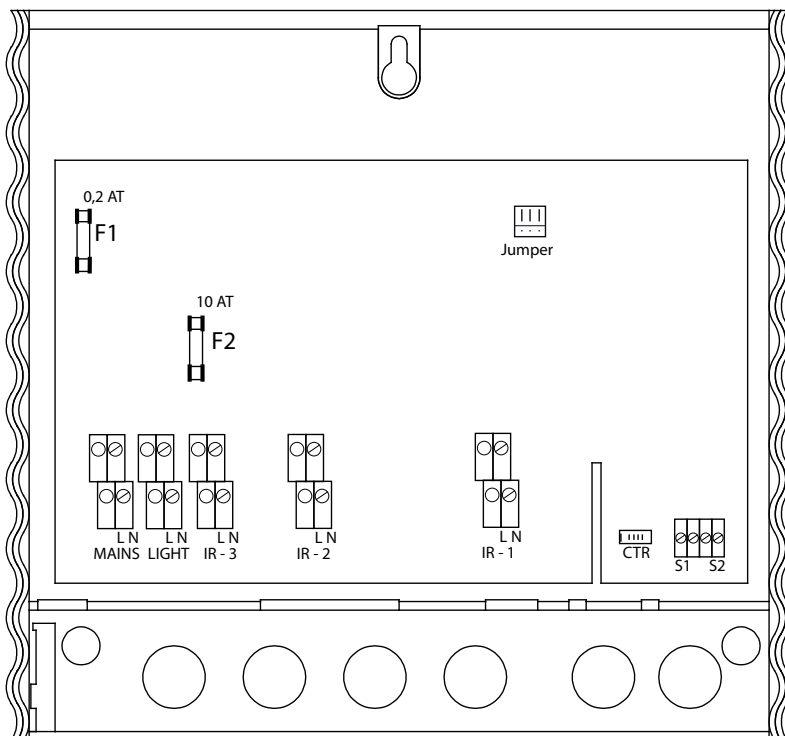

Connection diagram for IR radiant heaters

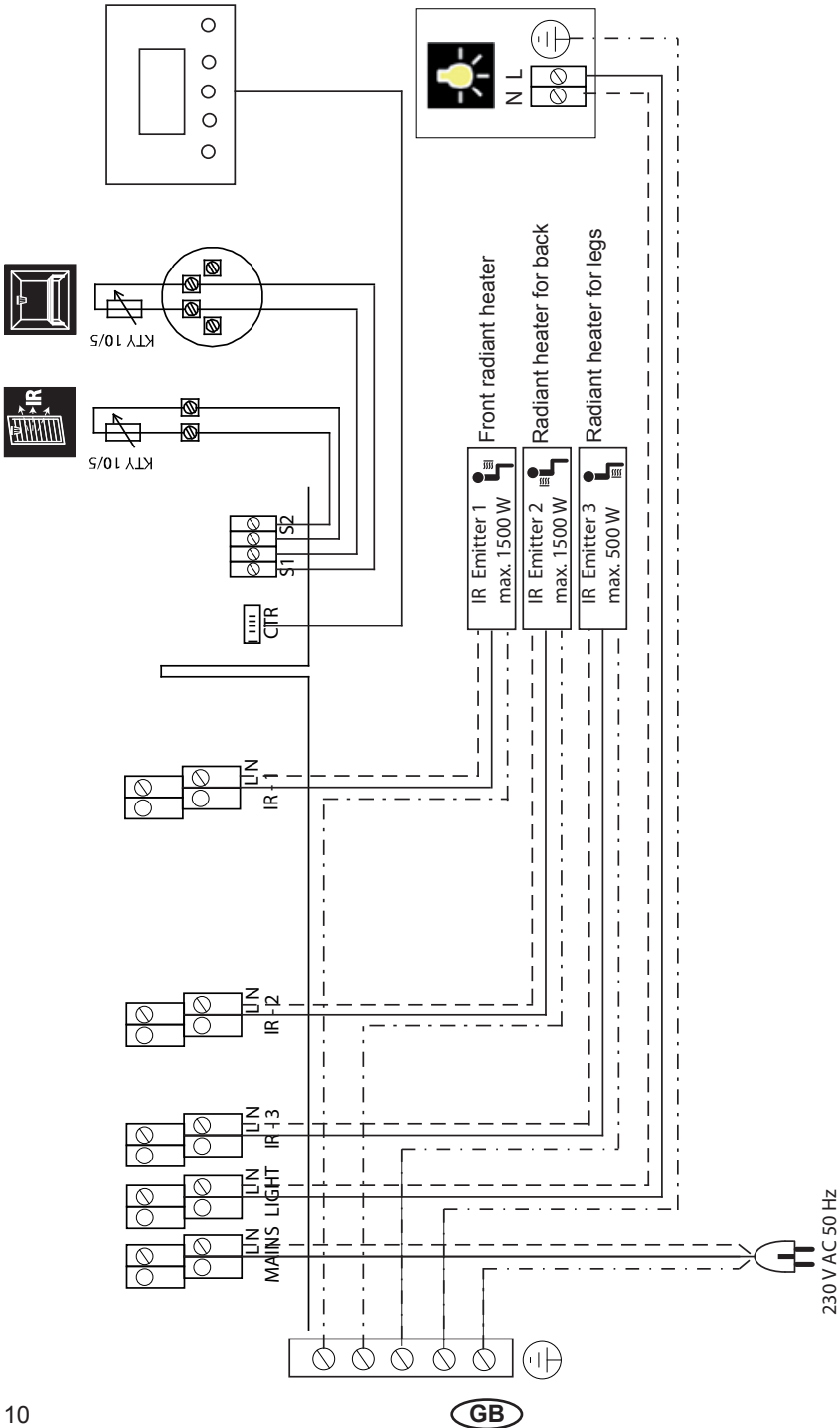

Connection diagram for IR heating foils

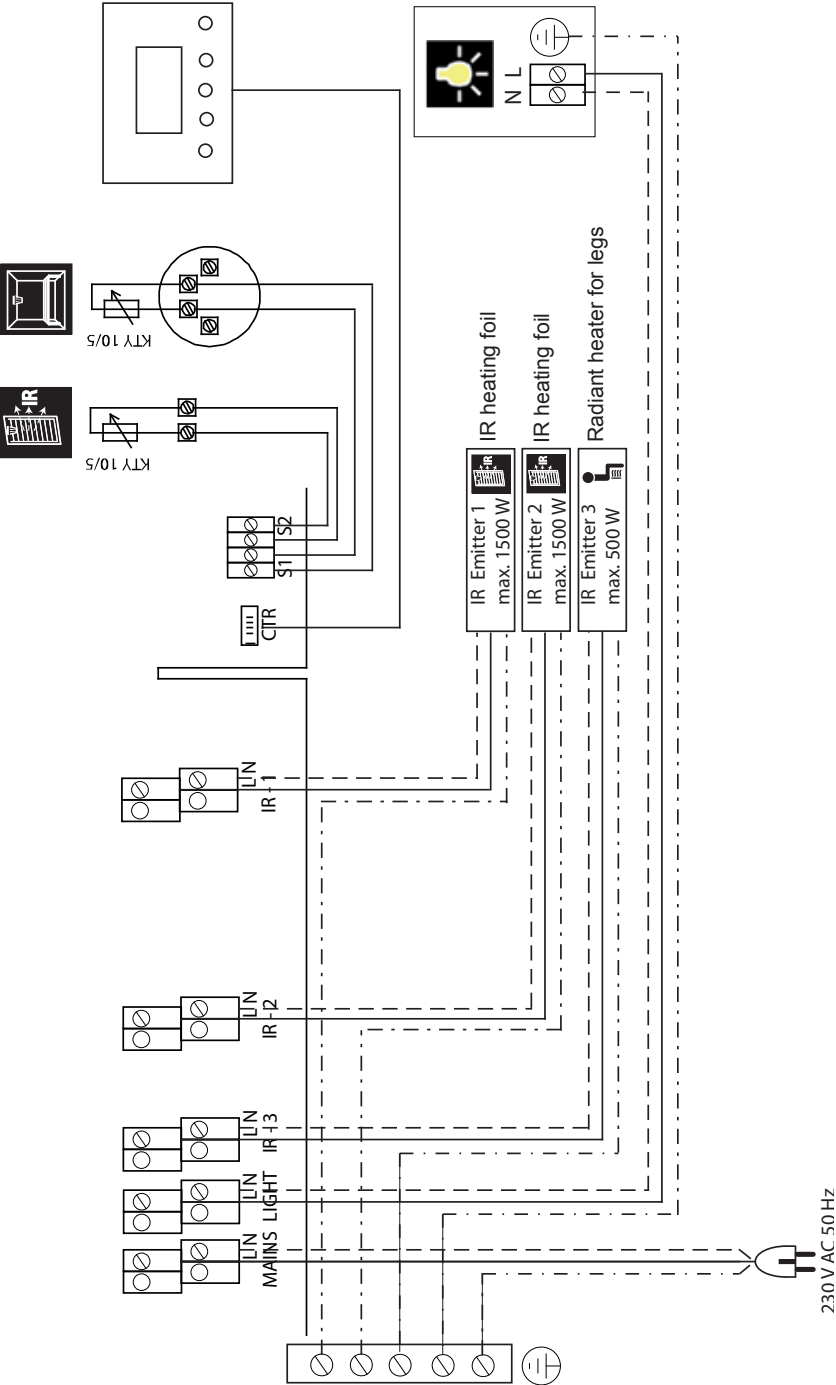

Connection diagram for IR radiant heaters and IR heating foils

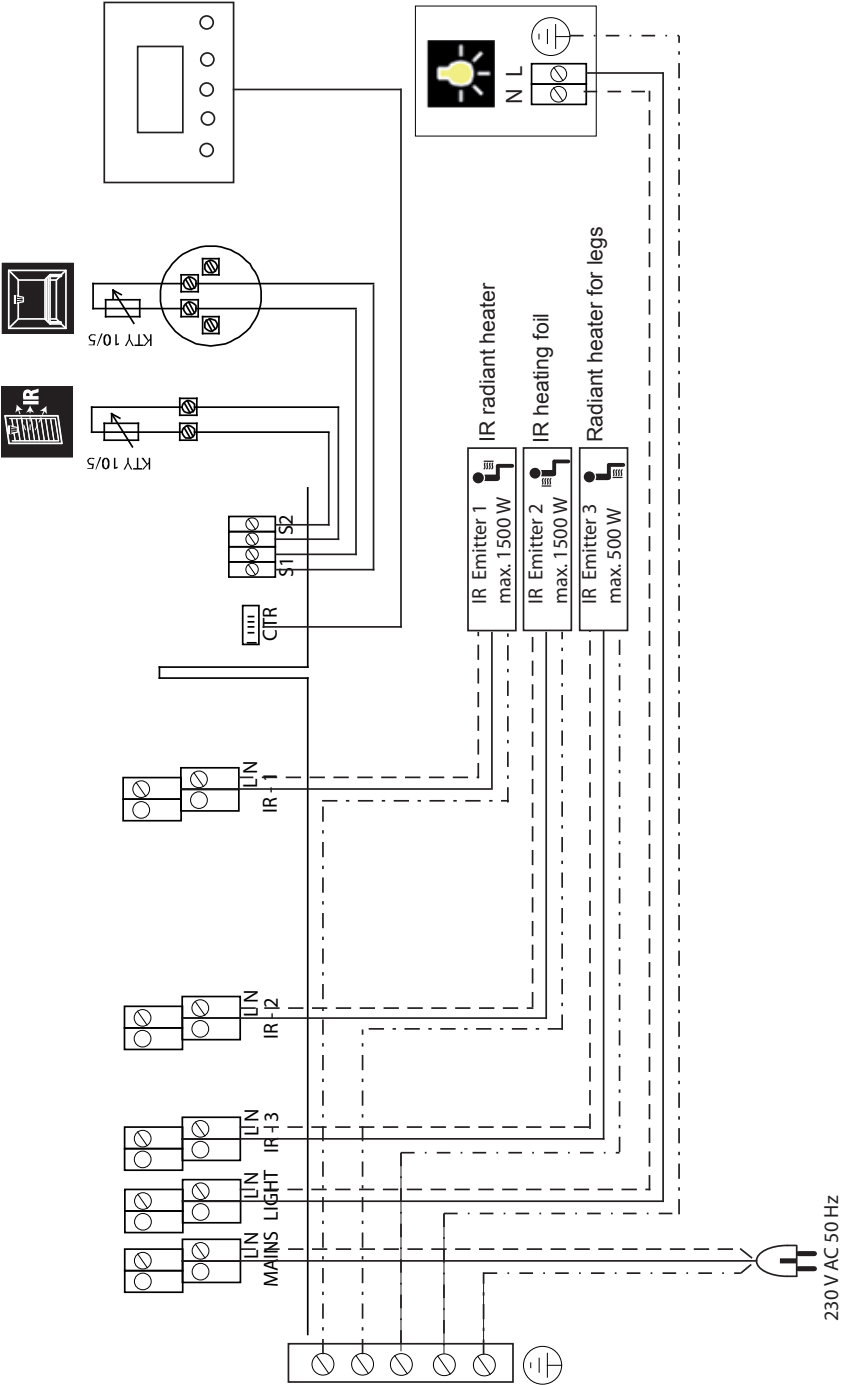

Connecting the sensor cables

You should not install sensor and power supply lines together, or lead them through the same feedthrough. This can lead to interferences in the electronics, such as "fluttering" in the relays. If it is necessary to lay the cables down together, or if the line is longer than 3m, use a shielded sensor cable (2 x 0.5 mm²).

Connect the shielding to ground in the control unit.

Please observe that the following dimensions relate to the values stipulated during the unit inspection acc. EN 60335-2-53. Theroom sensor must always be mounted on the ceiling in the centre of the room. The following Figs. give you an overview of the installation point for the sensor.

2. Drill a hole to lead the cable through, preferably through the middle of one of the wooden boards.
3. Guide the sensor cable through the drilled hole and attach it to the sensor line according to the Fig. below.

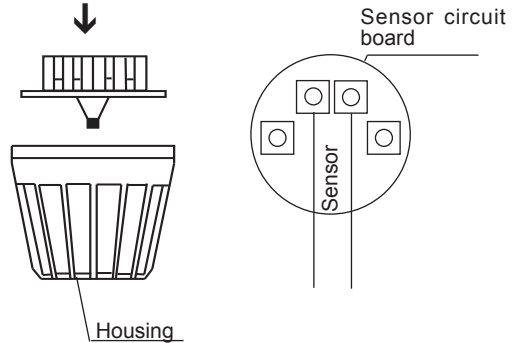

Installation of the room sensor

1. The heater sensor is mounted in the centre of the cabin ceiling.

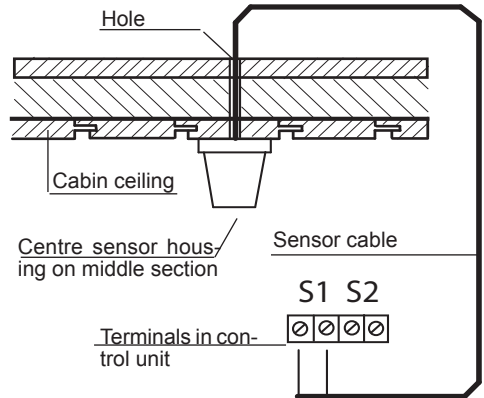
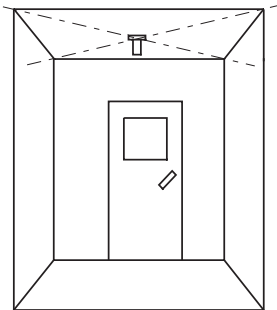



Installation of the optional heating foil sensor

- Fix the heating foil sensor outside the IR heating foil with the strain relief

Installation location: The heating foil sensor is mounted in the area of the overheating protection of the smallest heating foil installed and is fixed with a strain safeguard.



CAUTION- Measurement value falsification

If the heating foil sensor is not directly mounted onto the IR heating foil, the measurement values are falsified. Therefore place the heating foil sensor directly onto the heating foil.



Only mount the heating foil sensor when using IR heating foils with integrated overheating protection.

- Mount the sensor directly between the heating foil and the insulation.



CAUTION!!

Do not damage the IR heating foil during installation

- Lay the sensor line to the control power unit and connect to the S2 terminals.

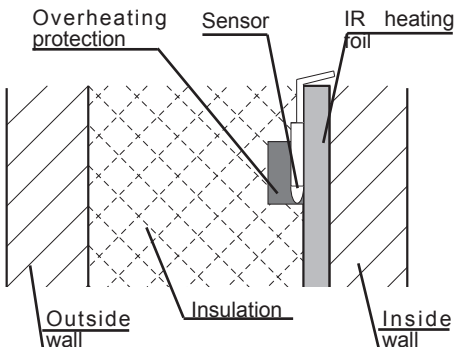
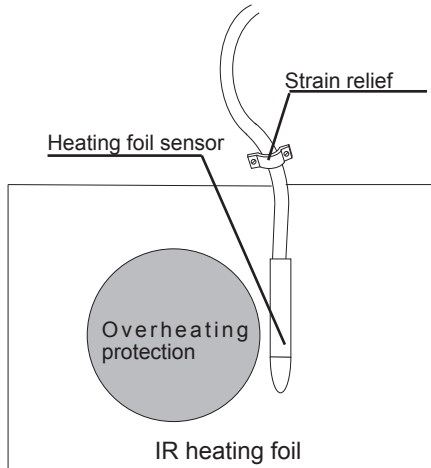

Operation

Once the system has been installed with all components and all covers have been fixed, you can put your IR cabin into operation.

Over the following pages we will show you the options provided to you with the control.





General

The user interface



The Fig. shows the operating unit in Stand-by mode with the light switched on.

Operating buttons

-  = Cabin lighting
-  = System On - Off
-  = Programming mode
-  = Increase the value
-  = Decrease the value

Default display Stand-by

is shown if the system is in Stand-by mode.

Reset to this display takes place from other menu items if no activity is carried out > 15 s.

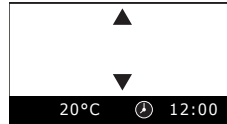

Default display in operation

is shown if the system is in operation.

Reset to this display takes place from other menu items if no activity is carried out > 15 s.



Energy-saving display

If the unit is not used, it will switch after 15 seconds into energy-saving mode. First the background lighting is switched off and then a moving time is shown after 30 minutes, similar to a PC screensaver.

By pressing any key you can return to the Stand-by default display

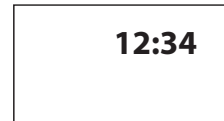

The following applies for all settings:

The following is shown at the bottom area of the display:



Cabin lighting switched on



Current cabin temperature



The Clock - Symbol

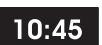

Current time

If the field around a value in the bottom part of the display is shown in black, this value can be changed using ▲ or ▼.



Modifiable value

If no key is pressed for > 15 s., the unit switches back into the default display. Changes made up to then are not saved

All settings out of Stand-by are confirmed by pressing  > 3 s and saved in the unit. After saving, the changed value will flash twice.

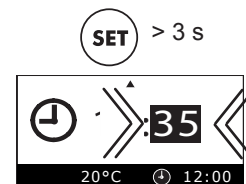

Initial commissioning

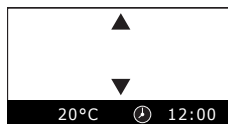
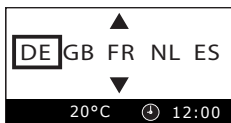
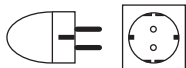

Change language

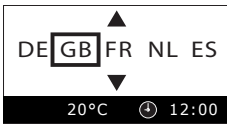
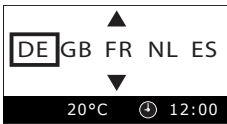
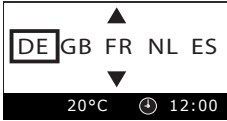
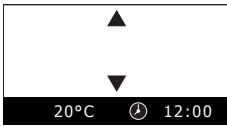

Change time

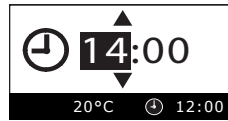
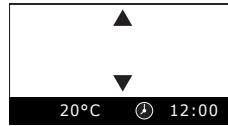

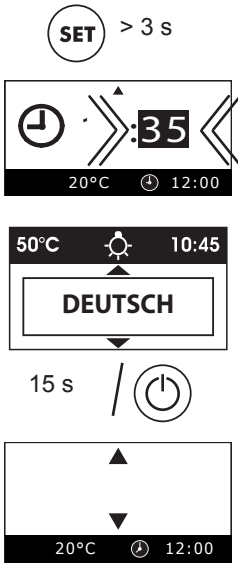

Foil temperature

If IR heating foil and the optional heating foil sensor are connected to your IR cabin, the maximum permitted temperature for the IR heating foil is set.

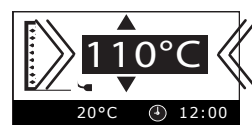
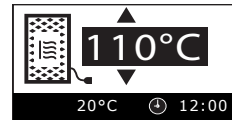
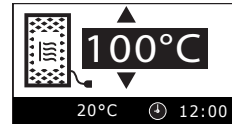
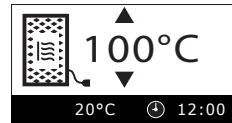
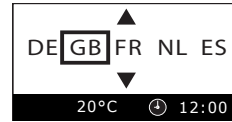
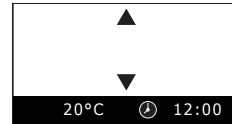



15 s / 

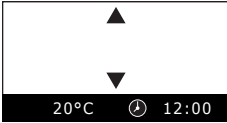

Switching on the IR system

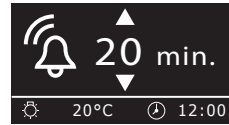
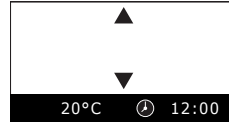

Switching off the IR system



20 minutes / 

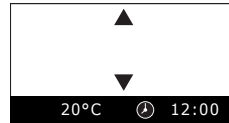

Individual settings

Below we show you the options for adapting the controls to your individual requirements. Permanent changes can only be carried out in Stand-by mode.

The individual parameters can be changed in the same way during operation. These changes take effect immediately and are not saved. They apply only for the respective session.



Room temperature

In Stand-by

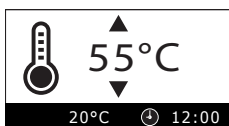
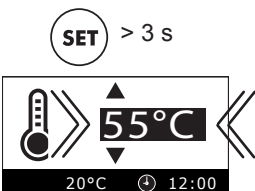
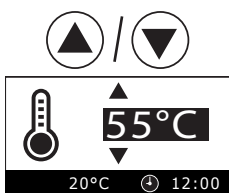
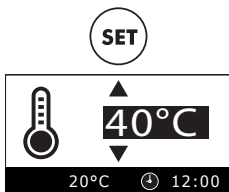
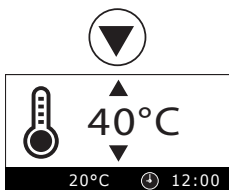
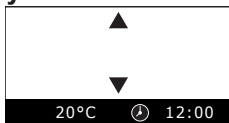

15 s /

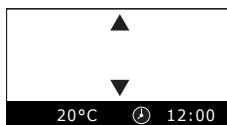

In operation

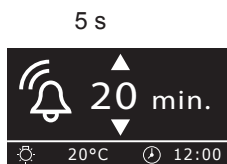
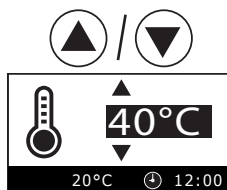
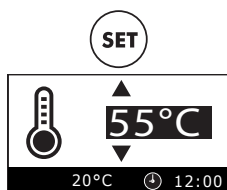
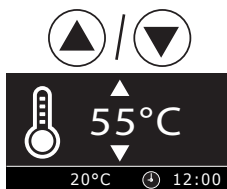



Room temperature for heating foil operation

The display shows the temperature value to be regulated in the central area (40/55° C).

In Stand-by

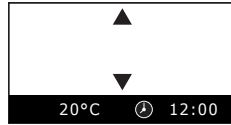
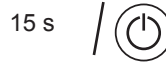
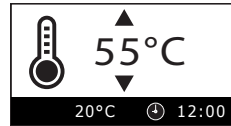
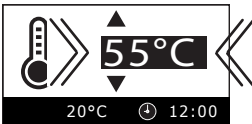
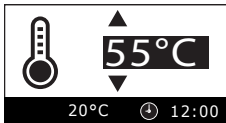
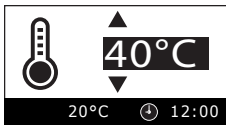
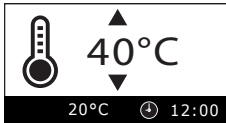
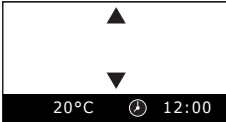

In operation

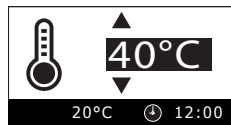
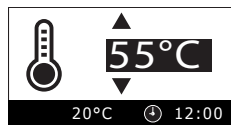

5 s





Radiant heater for legs

In Stand-by

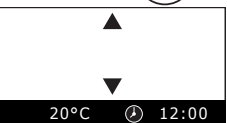
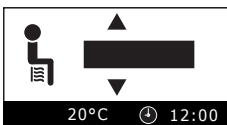
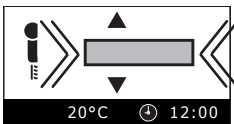
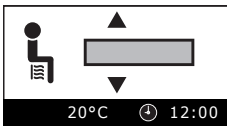
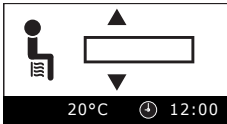
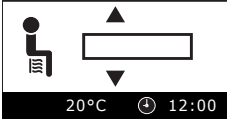
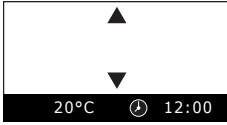

In operation

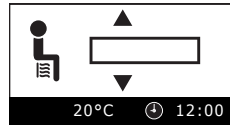
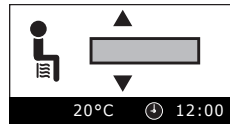
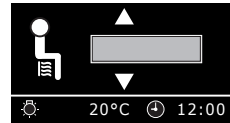

5 s





Radiant heater for back

Only possible when operated with IR radiant heaters

In Stand-by

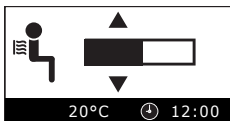
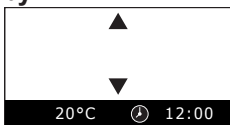

SET

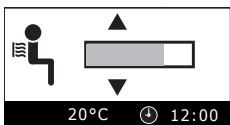
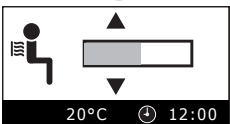

SET > 3 s

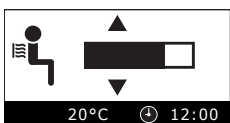
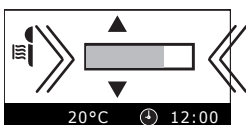

15 s / [Power Off Icon]

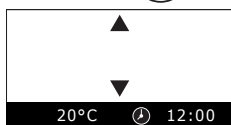

If the radiant heater power is reduced in Stand-by mode, the radiant heaters will still heat with 100% power up to a room temperature of 30° C.

Over 30° C, the radiant heater power is reduced to the set value and the cabin is heated to max. 70° C.

The room temperature function is put out of operation.

In operation

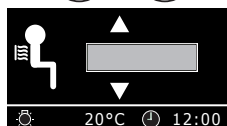

SET

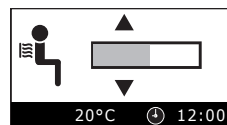
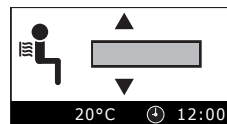

5 s





Front radiant heater

Adjustable in operation with IR radiant heaters and in combination mode (radiant heaters & foils)

In Stand-by

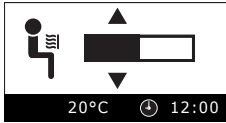
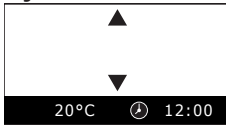

SET

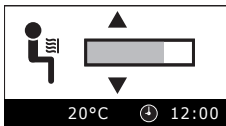
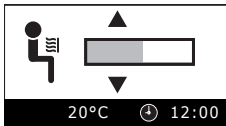

SET > 3 s

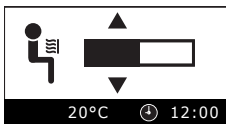
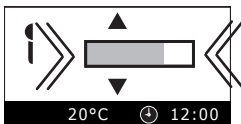

15 s

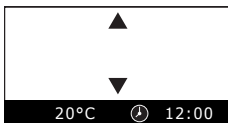

If the radiant heater power is reduced in Stand-by mode, the radiant heaters will still heat with 100% power up to a room temperature of 30° C.

Over 30° C, the radiant heater power is reduced to the set value and the cabin is heated to max. 70° C.

The room temperature function is put out of operation.

In operation

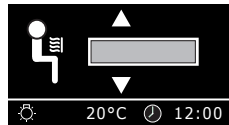

SET

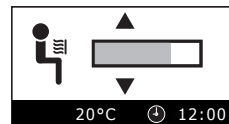
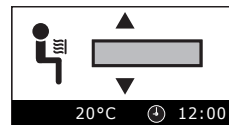

5 s





Heating time

In Stand-by

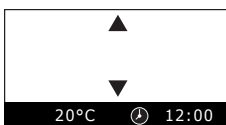
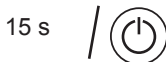
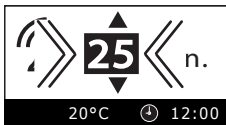
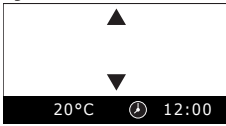

In operation

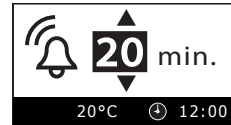
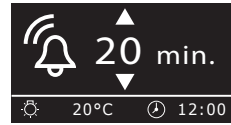

5 s



Error messages

The control unit continuously monitors the sensor for short circuits and interruptions. However, here only the sensors which are activated are monitored. That means:

If only IR radiant heaters are connected, only the room sensor is monitored:

If only IR heating foils are connected, both sensors are monitored.

If both IR radiant heaters and IR heating foils are connected, both sensors are monitored.

The error messages appear as follows:

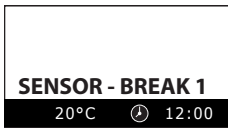

= Interruption in the room sensor circuit



= Short circuit in the room sensor circuit

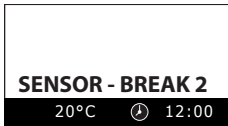

= Interruption in the foil sensor circuit



= Short circuit in the foil sensor circuit

If one of these messages appears, have the system checked by a specialist.

At room temperature (approx. 20° C), the sensors have a resistance of approx. 2 k Ω.

Please keep this address in a safe place together with the installation guide.

To help us answer your questions quickly and competently, please provide data printed on the ID plate, to include system type, article no. and serial no., in all inquiries.

Service Address:

EOS-WERKE GÜNTHER GmbH
Adolf-Weiß-Straße 43
35759 Driedorf-Mademühlen, Germany
Fon: +49 (0)2775 82-0
Fax: +49 (0)2775 82-431
servicecenter@eos-werke.de
www.eos-werke.de

Guarantee

The guarantee is taken over according to the legal regulations at present.

Manufacturer's warranty

- The period of warranty starts from the date of purchase and lasts up to 2 years for commercial use and 3 years for private use.

- Always include the completed warranty certificate when returning equipment.

- The warranty expires for appliances which have been modified without manufacturer's explicit agreement.

- Damages caused by incorrect operation or handling through non-authorized persons are not covered under the terms of warranty.

- In the event of a claim, please indicate the serial number as well as the article code number and type name with expressive description of the fault.

- This warranty covers damaged parts but no defects due to wear and tear.

In case of complaint please return the equipment in its original packaging or other suitable packaging (caution: danger of transport damage) to our service department.

Always include the completed warranty certificate when returning equipment.

Possible shipping costs arising from the transport to and from point of repair cannot be borne by us.

Outside of Germany please contact your specialist dealer in case of warranty claims. Direct warranty processing with our service department is in this case not possible.

Equipment start-up date:

Stamp and signature of the authorized electrician:

Handling procedures for return shipments (RMA) - Details for all returns !

Dear customer

we hope that you will rejoice in the ordered articles. Just in case that you are not entirely contented as an exception, please follow the procedures specified below. This enabling us to ensure a quick and smooth handling of the return shipment.

Please absolutely respect for all returns!

- Please add the available **RMA-voucher** always **completely filled out** together with an **invoice copy** to the return shipment! Do not stick it on the goods or on the packaging. **We do not accept the return shipment without these papers.**
- Not prepaid parcels **will be refused** and returned to Sender! Please always ask for the **RMA-No.** for the cheapest return.
- **Please pay attention that** the goods have to be sent back **without visible marks of use** in the **original scope of delivery and in original packing.**
- We recommend to use an **additional solid and break-proof covering box** which should be padded out with styrofoam, paper or similar. Transport damages as a result of faulty packing are for the sender's account.

Form of complaint:

1) Transport damage

- Please check the content of your parcel immediately and advise the forwarding company of a claim (parcel service/ freight forwarder)
- Do not use damaged goods!
- Ask the forwarder **for a written acknowledgement of the damages.**
- **Report the claim promptly by phone to your dealer.** He will discuss with you how to act in this case.
- If the transport box has been damaged, please use an additional covering box. Do not forget to add the **acknowledgement of the damage of the forwarding company !**

2) Faulty goods

- The implied warranty period is 2 years. Please contact your dealer in case of **faulty or wrong articles or missing accessories.** He will discuss with you the individual case and try for immediate and customer-friendly solution.
- For **economic returns** within Germany you will get an **RMA-number from the manufacturer.**
- All returns have to be in the **original packing of the goods with corresponding accessories.** Please repack the goods to avoid damages. In case of wrong delivery, please do not use this article !

3) Problems of installation and functioning

- Please **read the manual carefully first of all** and pay attention to the indicated assembly or installing instructions.
- **Your dealer should be the first contact person** because he knows his products best and also knows possible problems.
- **In case of function problems with an article,** please check at first whether there is an obvious material defect. The quality system in our factory reduces malfunctions of new appliances to almost zero.